

PEES Power Systems

Nuclear power compared to solar power



Nuclear power compared to solar power



Solar Energy vs. Nuclear Energy: A Comparative Analysis

A comparison of solar and nuclear energy reveals significant differences in their methods of energy production, implementation costs, efficiency in electricity generation, and overall ...

Nuclear Energy vs Solar Power: Costs, Safety & Sustainability

Explore nuclear energy drawbacks & solar power benefits. Compare costs, safety, and sustainability for a cleaner, cost-effective energy future.



Energy Shift: Nuclear vs. Solar Energy - What's the Game Changer?

This article will compare nuclear and solar energy, looking at their pros and cons. It will also check out recent innovations that could be game changers, and explore policy directions to shift ...

IAEA Hosts First International Symposium on AI and Nuclear Energy

Global energy and technology leaders are gathering this week at IAEA headquarters in Vienna for the first ever International Symposium on Artificial Intelligence (AI) and Nuclear Energy. ...

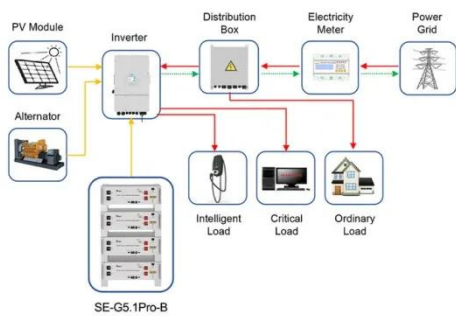

Application scenarios of energy storage battery products

Nuclear technology and applications , IAEA

The IAEA assists its Member States in using nuclear science and technology for peaceful purposes and facilitates the transfer of such technology and knowledge in a sustainable manner to ...

Nuclear Explained

The articles and videos on this page offer easy-to-understand explanations of major topics in nuclear science and technology. The many peaceful uses of nuclear technology have a beneficial impact on ...



Nuclear energy, safe use of nuclear power , IAEA

The IAEA fosters the efficient and safe



use of nuclear power by supporting existing and new nuclear programmes around the world, catalysing innovation and building capacity in energy ...

What is Nuclear Energy? The Science of Nuclear Power

What is nuclear fission? Nuclear fission is a reaction where the nucleus of an atom splits into two or more smaller nuclei, while releasing energy. For instance, when hit by a neutron, the ...





Nuclear Explained

Nuclear fusion is the process by which two light atomic nuclei combine to form a single heavier one while releasing massive amounts of energy. Fusion reactions take place in a state of ...

2025 Wrapped: IAEA's Most-Read Nuclear Explainers

1. Understanding Nuclear Energy One of the IAEA's most popular articles in 2025 was the explainer on What is Nuclear

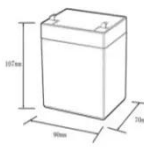
Energy? Readers learned about how splitting atoms generates ...

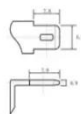
12.8V6Ah

Nominal voltage (V):12.8
 Nominal capacity (Ah):6
 Rated energy (WH):76.8
 Maximum charging voltage (V):14.6
 Maximum charging current (A):6
 Floating charge voltage (V):13.6-13.8
 Maximum continuous discharge current (A):10
 Maximum peak discharge current @10 seconds (A):20
 Maximum load power (W):100
 Discharge cut-off voltage (V):10.8
 Charging temperature (°C):0-+50
 Discharge temperature (°C):-20-+60
 Working humidity: <95% R.H (non condensing)
 Number of cycles (25 °C, 0.5C, 100%DoD): >2000
 Cell combination mode: 32700-4s1p
 Terminal specification: T2 (6.3mm)
 Protection grade: IP65
 Overall dimension (mm):90*70*107mm
 Reference weight (kg):0.7
 Certification: un38.3/msds

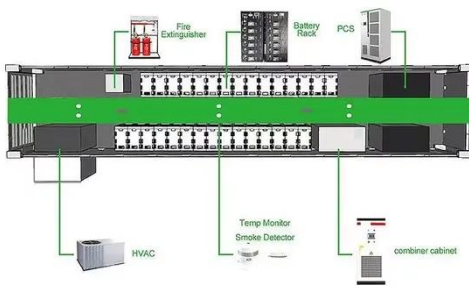

Energy Showdown: Solar Vs Nuclear In 2025

Compare solar and nuclear energy in 2025. See which offers better cost, safety, and sustainability as the world seeks reliable clean power sources.

Nuclear Power vs. Solar Energy: Pros, Cons, and ...

Nuclear power and solar energy both offer benefits for clean energy, but which is more sustainable? Learn the pros and cons of each.

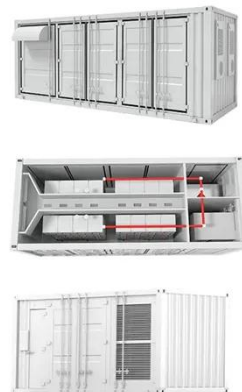

Energy, Electricity and Nuclear Power Estimates for the Period up to

The 45th edition of Reference Data Series No. 1 contains estimates of

energy, electricity and nuclear power trends up to the year 2050. In deriving the nuclear capacity projections, all operating reactors, ...



Empirical Comparison Between Nuclear and Solar Power

To summarize, the all nuclear power scenario had an order of magnitude higher cost compared to the all solar power scenario while the all solar scenario had 2 orders of magnitude more space needed ...

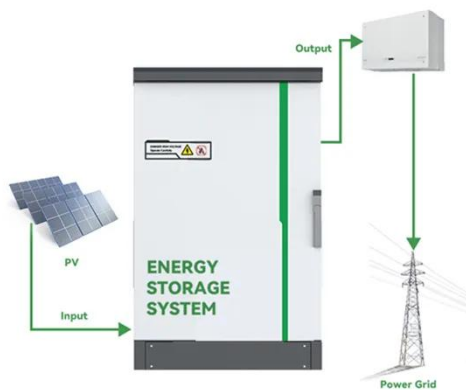

Nuclear and Solar Energy: Pros, Cons, and How They ...

Explore the pros and cons of nuclear and solar energy, comparing efficiency, cost, and sustainability for a cleaner energy future.

Nuclear Power vs. Solar Power

Ultimately, both sources have their place in the energy mix, with nuclear power providing a stable base load and solar

power contributing to a more sustainable future. One of the key differences between ...



International Atomic Energy Agency , Atoms for Peace and Development

The IAEA is the world's centre for cooperation in the nuclear field, promoting the safe, secure and peaceful use of nuclear technology. It works in a wide range of areas including energy ...

Is Nuclear Energy Better Than Solar Energy?

To match the annual energy output of a 1,000-megawatt nuclear plant, a solar farm would need to install several times that capacity, requiring a vast physical area. Land-use requirements ...



Comparison between solar energy and nuclear energy

In this analysis, we will explore these

12V 10AH



two energy sources in depth, comparing their origin and operation, energy efficiency, environmental impact, safety, costs and viability.

Top 'Nuclear Explained' Reads in 2024 , IAEA

Nuclear energy was in the spotlight in 2024 as the IAEA and the Government of Belgium organized the world's first Nuclear Energy Summit, and the IAEA raised its projections for nuclear ...



Contact Us

For catalog requests, pricing, or partnerships, please visit:
<https://www.peregrine-energy.co.za>

